



Electric scissor lift

JCPT1412DC / JCPT1612DC

Electric scissor lift JCPT1412DC / JCPT1612DC









STANDARD EQUIPMENT

- Proportional controls
- Automatic pothole protection
- Self-lock gate on platform
- Drivable at full height
- Non marking tires
- 2WD
- Automatic brakes system
- Emergency lowering system
- Emergency stop buttons
- Cylinder holding valve
- Onboard diagnostic system
- Tilt sensor with alarm
- All motion alarm
- Horn
- Hour meter
- Safety brackets
- Forklift pockets
- Folding guardrails
- Extended platform
- Charger protection
- Flashing beacon

OPTIONS

- Overload sensor with alarm
- AC power to the platform
- Platform work lights
- Airline to the platform

SPECIFICATIONS

	JCPT1412DC	JCPT1612DC
 S.W.L.	320 kg	200 kg
S.W.L. on extension	113 kg	113 kg
Maximum workers	3	2
 Working height	13,8 m	15,7 m
Platform floor height	11,8 m	13,7 m
 Overall length	2,48 m	2,84 m
Overall width	1,19 m	1,25 m
Overall height (rails up/down)	2,59/2,05 m	2,59/2,05 m
Platform size	2,27x1,12 m	2,64x1,12 m
Platform extension size	0,90 m	0,90 m
Ground clearance (stowed/raised)	0,1/0,019 m	0,1/0,019 m
Wheelbase	1,87 m	2,22 m
Turning radius (inside/outside)	0/2,20 m	0/2,65 m
 Drive motors	24 V / 1,5 kw	24 V / 1,5 kw
Lifting motors	24 V / 3 kw	24 V / 4,5 kw
 Travel speed (stowed/raised)	4,0/0,8 km/h	4,0/0,8 km/h
Up/Down speed	84/38 sec	88/60 sec
 Batteries	4x6 V / 210 Ah	4x12 V / 300 Ah
Integrated charger	24 V / 25 A	24 V / 25 A
 Gradeability	25 %	25 %
Maximum working slope	1,5-3°	2-3°
 Driving wheels	Φ 381x127 mm	Φ 381x127 mm
 Weight	2880 kg	3180 kg

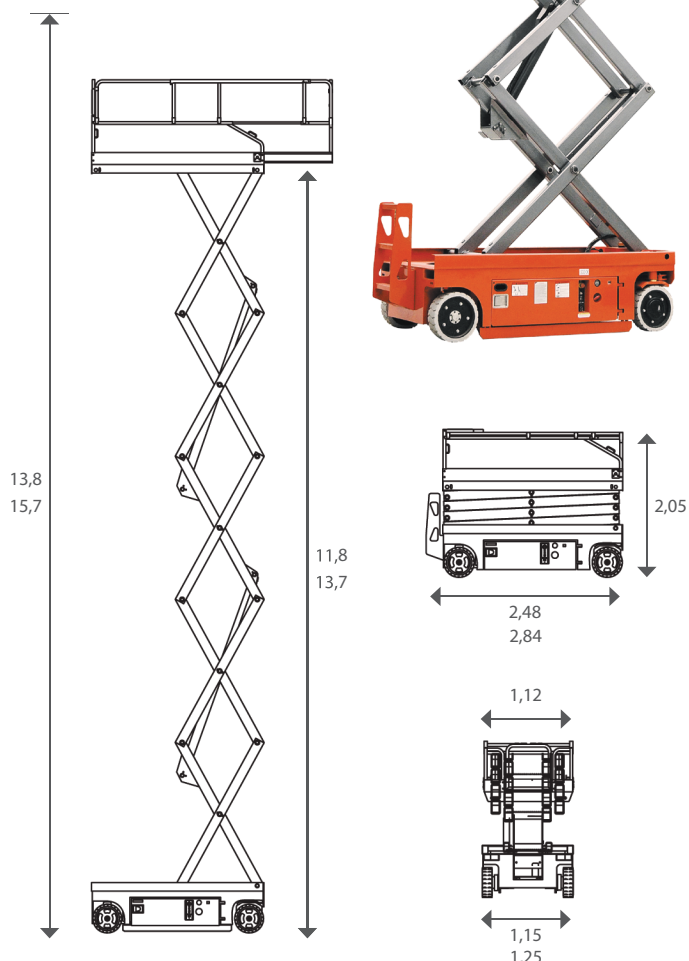

CE This product is available with the CE mark confirming compliance with all relevant European Machinery Directives

www.dingli.eu

INSTANT

Norway
Tel.: +47 23 19 11 00
info@instant.no

Lithuania
Tel.: +370 5 233 1096
info@instant.lt

Latvia
Tel.: + 371 263 58 152
info@instantlatvija.lv

Estonia
Tel.: +372 680 76 33
info@instant.ee